

8.009
8.004
8.001
8.002
8.003

Assembly instructions

This product should be installed by a qualified electrician
in accordance with current electrical standards and regulations

ELECTRIC HEATER ELEMENT KIT

Parts Supplied

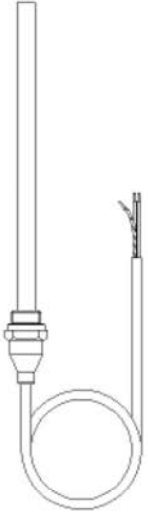
Ref	Description	Illustration	Qty
A	Electrical heating element		1

Fitting parts NOT supplied - Optional

Ref	Description	Illustration	Qty
B	T-Piece		1

Tab. 1

TOOLS REQUIRED (NOT SUPPLIED)

27 mm Spanner
P.T.F.E Tape
Blanking plug (Ref. C)

APPLICABLE EUROPEAN STANDARD (only for electrical heating element)

Electrical tests according to CEI EN 60335-1 (except paragraph 10)

Applicable directives: 2002/95/CE and 2011/65/CE RoHS Directive and 2006/95/CE Low Voltage Directive



Eastbrook 
Eastbrook Road, Gloucester GL4 3DB
Technical Helpline : 01452 317890
Mon - Fri / 8am - 5pm
Email : technical@eastbrookco.com

CAUTION

GENERAL CAUTION

- Read the instruction carefully before install and use the electric heater element kit.
- The product is an heating element designed for installation in standard domestic towel radiators. It should not be used for any other purpose.
- All fittings must be installed by a competent person in accordance with current IEE Wiring Regulations (BS7671). If you are in any doubt about installing this product, consult a qualified electrician.
- Installation must be carried out in accordance with conditions described in the Technical specification table, and all applicable rules and regulations.
- The electrical heating element must be carefully selected in proportion to function of the towel radiator size and thermal output. To select the electrical power (in case of PTC models, the electrical power reference value of the electrical heating element to consider for a correct coupling with the towel rail is the nominal power increased by 35%), refer to the towel rail manufacturer instructions when a certification related to the complete system (according to EN 60335-2-43) issued by a European recognised institute (like SEMKO, VDE, ...) is available. In case of missing towel radiator manufacturer certification, contact a qualified electrician who must refer to EN 60335-2-43 and EN 442-2-43. The electrical heating element power installed must be much lower than the thermal power of towel radiator calculated with □□□□ (EN 442-2).

SAFETY WARNINGS

- The electrical heating element is a class I device and it is protected against water ingress according to its IP degree of protection. The towel radiator where the electrical heating element is fitted must be mounted inside the zone of the bathroom according to its IP degree of protection and electrical legislation in force. In case of doubt to determine the installation zone, refer to the relevant public institution.
- Before carrying out any installation, de-installation, cleaning or maintenance, disconnect the electrical heating element from the mains.

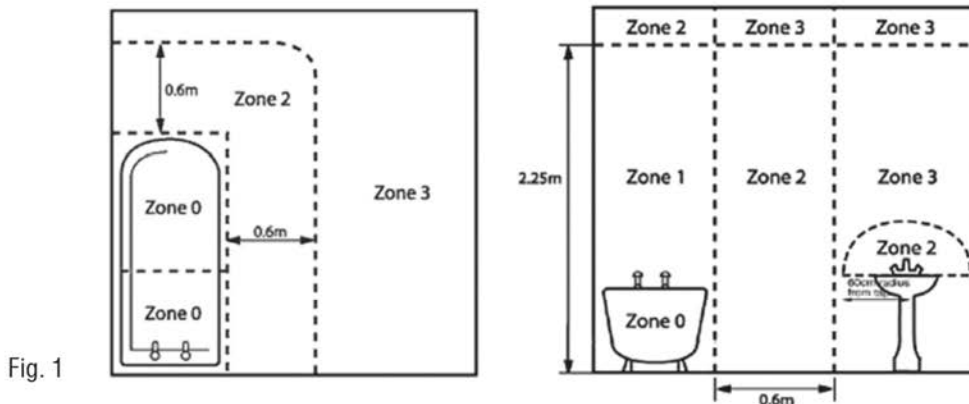

SAFETY INFORMATION

- Do not install the electrical heating element into a towel radiator fitted in ZONE 0 or ZONE 1 (Fig 1).
- The electrical heating element must only be fitted vertically from the bottom of the towel radiator.
- Verify that the rated voltage of the heating element is the same as the supply voltage.
- Do not power the heating element until it is completely fitted into a filled towel radiator.
- In 'Electric only' heating element installation, the towel radiator MUST have a sufficient air gap to allow for water expansion (about 10%).
- **The electrical heating element MUST only be operated if completely immersed in liquid (water) inside the tower radiator.**

MAIN RECOMMENDATION ON ELECTRICAL TOWEL RADIATOR (Applicable standard EN 60335-2-43)

- The electrical heating element can be used in a 'stand alone' towel radiator, or in a centrally heating system to provide heating of the towel radiator when the rest of the system is switched OFF (e.g. during the summer). It should NOT be used when the central heating system is ON.
- The electrical towel radiator is intended only for drying towels washed in water. Any other use is forbidden.
- In 'Dual-fuel' installation with central heating and electrical heating element, at least one of the rail valves must always be left open, when the electrical element is switched ON.
- It is recommended to use in each installation a self relief pressure valve on the top part of the rail in the opposite side to where the electrical heating element is installed. In case of valve intervention, it is quite normal for liquid relief and water excess to possibly reach the floor. For further information and/or to purchase a self relief pressure valve please contact the Customer Care Line below.
- For all other aspects, refer to EN 60335-1 and EN 60335-2-43.

GUARANTEE

- The electrical heating element is guaranteed for 12 months against any manufacturing defects from the date marked on it.
- The guarantee is not valid in case of improper use or installation.

CONTACTS DETAILS

Eastbrook Company
Eastbrook Road
Gloucester
GL4 3DB
Tel 00441452317800
Fax 00441452330494
Customer Care Line
01452317800

PRODUCT PRESENTATION

The product is an heating element sized to give a comfortable rail surface temperature in its correct size of towel radiator.

Note: According to the geometry, treatment, construction material and liquid (water or water and glycol) of a specific towel radiator with the electrical heating element the thermal distribution can be significantly different. For specific performance, you must refer to the towel radiator manufacturer or carry out specific tests.

SYMBOLS AND GLOSSARY

Heating element nipple: The nipple is a part of the electrical heating element and allows its fitting to the towel radiator through a thread (1/2" GAS - UNI ISO 228)

Nipple thread: The upper side of the nipple which allows the fitting of the heating element into the towel radiator. It is a 1/2" GAS.

O-ring: it is a ring gasket acting as a mechanical seal that fills the space between two mating surfaces to prevent leakage from or into the joined objects while under compression.

Towel radiator female thread: it is the threaded hole of the towel radiator where the heating element is intended to be fitted. This hole has a 1/2" GAS female thread for a correct coupling towel radiator/electrical heating element.

PTC model: is a particular construction of the electrical heating element, it incorporates semiconductor components which are decreasing the wattage when temperature is raising.

TECHNICAL DATASHEET

SPECIFICATION FOR CLASS I TYPE

Item p/n	Power (W)	Length (mm)
8.009 100W	100	180
8.004 150W	150	220
8.001 300W	300	300
8.002 600W	600	620
8.003 900W	900	920

TECHNICAL SPECIFICATION TABLE

Rated Voltage	230 V \pm 10% AC 50 Hz
Heating Element Power	100-150-300-600-900W
Power tolerance	\pm 35% for PTC models
Insulation class	Class I
IP Degree of Protection	IP55
Operating Temperature	0 \div 50°C
Storage Temperature	-20 \div 80°C
Operating relative Humidity	0 \div 85% without condensation

INSTALLATION

BEFORE YOU START

- Check the packaging and make sure you have all of the parts listed in Tab. 1 with no visible signs of damage. If any of the part is missing or appears damaged, you should return them to the point of purchase.
- Check that you have the correct element for your towel radiator. It is essential that the correct size element is installed according to the recommendation stated on the packaging or instructions of your towel radiator. If you are unsure, please call the customer care line
- Decide on an appropriate location for your product.
- When you are ready to start, make sure that you have the right tools at hand, plenty of space and a clean dry area for assembly.
- It is important that the correct choice of the heater is made according to the sizing guide. The towel radiator will get HOT so it is not suitable for use in locations where this could cause a hazard (e.g. where infirm persons or young children will be present unsupervised).

INSTALLATION WARNINGS

- The electrical heating element must be completely installed into the filled towel radiator before to switch it ON and make sure the electrical heating element is completely immersed into water.
- All-pole disconnection from the supply is required, incorporated in the fixed wiring. Switches intended to ensure all-pole disconnection must be directly connected with the supply terminals and must have a contacts distance of at least 3 mm in each pole.
- Check that the electricity supply system is connected through an MCB (Magnetothermic Circuit Breaker) and RCCB (Residual Current Circuit Breaker) devices.
- Protect the electrical supply with a high sensitivity differential device.
- Do not use the electrical heating element to lean the electrified towel radiator on the floor as you can damage the product and water can penetrate inside with a risk of electrical shock.
- The electrical heating element must be permanently connected to a suitable electricity supply by way of the cable provided. This should be via a fused spur in accordance with the IEE Wiring Regulations (BS7671). If sited in the bathroom, the Fused Connection Unit must be located out of reach of persons using the basin, shower or bath. If in doubt, consult a qualified electrician.
- The electrical heating element is for use as Stand Alone Electrically heated or with Vented/Open Central Heating Boiler Systems only. If it is used with Sealed Systems or Combination Boiler Systems, it is essential that you establish that there is adequate allowance for expansion.

WARNING! DO NOT CONNECT THE POWER SUPPLY BEFORE IT IS COMPLETELY ASSEMBLED.

WARNING! DO NOT SWITCH ON THE UNIT IF THE RADIATOR IS EMPTY.

WARNING! DO NOT TOUCH THE HOT SURFACE OF THE HEATING ELEMENT.

'ELECTRIC ONLY' HEATING ELEMENT INSTALLATION

It is recommended that the installation is carried out by a qualified electrician.

1. **IMPORTANT.** Always switch off the electricity supply at the mains before installation and maintenance. We recommend that the fuse is withdrawn or circuit breaker switched off at the distribution board whilst work is in progress (turning off the switch is not sufficient).
2. The electrical heating element must be fitted to the towel radiator before mounting the radiator onto the wall.
3. Remove any transit plugs from the towel radiator.
4. Wrap P.T.F.E tape around the electrical heating element thread and the blanking plug thread (C).
5. Check that the o-ring is present on the nipple thread of the electrical heating element.
6. Insert the electrical heating element (A) into the chosen side of the towel radiator and tighten it into place using a 27 mm spanner.
7. Fill the towel radiator approximately 90% with water to allow for expansion making sure that the electrical heating element is completely immersed in water. Addition of glycol and possibly an inhibitor is recommended, as part of this percentage mix.
8. Insert the blanking plug (C) into the open tapping, and tighten it into place using 27 mm spanner.
9. Fit the towel radiator to the wall, following the towel radiator fitting instructions.
10. Verify that no water leakage occurs after the electrical heating element fitting operation and re-tighten joints as necessary and make sure all visible parts of the electrical heating element are completely dry before proceeding with.
11. Connect the electrical heating element to the mains power using a BS Fused Connection Unit. The wires should be connected as follows: Blue - NEUTRAL, Brown - LIVE, Green/Yellow - EARTH.
This product must be earthed.
12. The Fused Connection Unit should be fitted with a proper fuse to BS1362.
13. Switch on mains supply and test. The towel radiator should heat up. When the operating temperature has been reached, purge excess air from the towel radiator using the air vent. Check again there is no water leakage (in case of water leakage refer to DANGEROUS CONDITIONS AND RISKS section).

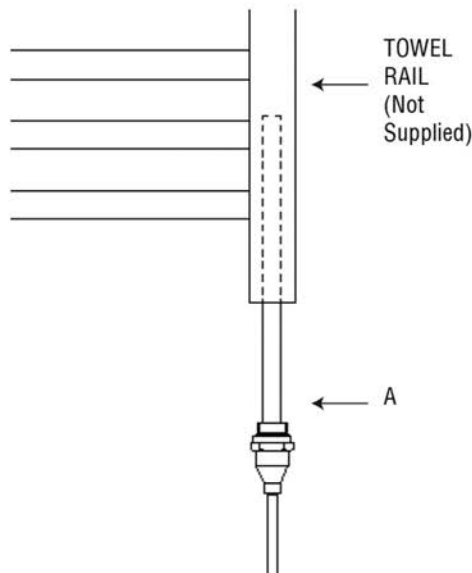

'DUAL-FUEL' INSTALLATION CENTRAL HEATING AND ELECTRICAL ELEMENT

It is recommended that the installation is carried out by a qualified electrician.

1. **IMPORTANT.** Always switch off the electricity supply at the mains before installation and maintenance. We recommend that the fuse is withdrawn or circuit breaker switched off at the distribution board whilst work is in progress (turning off the switch is not sufficient).
2. Wrap P.T.F.E tape around the electrical heating element thread and the T-Piece thread.
3. Check that the o-ring is present on the nipple thread of the electrical heating element.
4. Screw the electrical heating element (A) into the T-Piece (B) and tighten it into place with a 27 mm spanner.
5. Insert the T-Piece with the electrical heating element into the chosen side of the towel radiator and tighten into place using a 27mm spanner.
6. Follow the towel radiator fitting instructions to connect it to the central heating system.
7. To help prevent possible corrosion and lime scale formation it is recommended that a suitable inhibitor is added to the central heating system.
8. Open the valves to the radiator and, using the air vent, fill and purge the remaining air from all radiators, including the towel radiator with the heating system off.
9. Verify that no water leakage occurs after the electrical heating element fitting operation and re-tighten joints as necessary and make sure all visible parts of the electrical heating element are completely dry before proceeding with.
10. Connect the electrical heating element to the mains power using a BS Fused Connection Unit. The wires should be connected as follows: Blue - NEUTRAL, Brown - LIVE, Green/Yellow - EARTH.
This product must be earthed.
11. The Fused Connection Unit should be fitted with a proper fuse to BS1362.
12. Switch on mains supply and test. The towel radiator should heat up. Check again there is no water leakage (in case of water leakage refer to DANGEROUS CONDITIONS AND RISKS section).

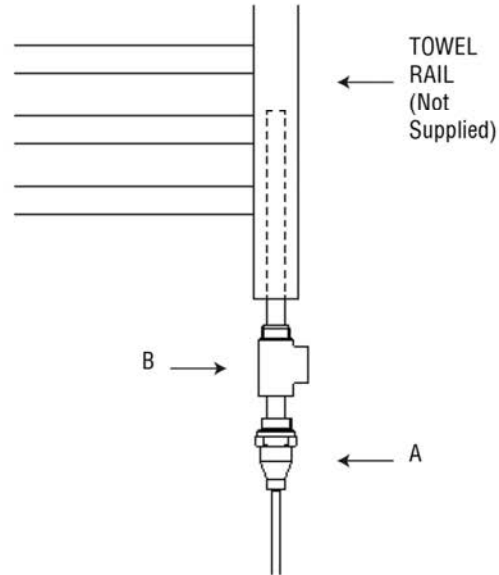

USAGE

USAGE WARNINGS

If the towel radiator does not heat at all, this may indicate operation failure and the product must be replaced. If the Magnetothermic Circuit Breaker has operated disconnect the electrical heating element and refer to dangerous conditions and risk section.

WORKING DESCRIPTION

The electrical heating element should be connected to a switch which is determining the status of the element itself: ON or OFF.

IMPROPER USE

- All different usages which are not described in the “PRODUCT PRESENTATION” section according to the “USAGE” section, are to be intended as improper usage. In case of doubts, refer to the seller.
- Never switch the electrical heating element ON if the towel radiator is empty.
- Before installation, never switch the electrical heating element ON to verify heating effectiveness.

DANGEROUS CONDITIONS AND RISKS

- During installation, de-installation and maintenance, ensure working place safety until the operation is completed.
- In case of any abnormal operation or if the product has visible signs of damage, disconnect the electrical heating element, contact the customer care line for advice, ultimately returning it to the seller for investigation or replacement if it is within the 12 months guarantee period.
- The electrical heating element cable can not be repaired. If it is damaged, don't use it and contact the point of purchase for replacement of the complete unit.
- Never try to modify or repair the electrical heating element by yourself.
- Never knock the electrical heating element against anything. Handle with extreme care during every operation and never leave it in wet areas.

MAINTENANCE

ORDINARY

- Pay particular attention to verify that there is no water leakage, checking the visible and exposed electrical heating element parts.
- Using the dedicated switch of the electrical heating element, verify that when turned ON the towel radiator should heat up and no heat is provided when turn OFF.
- If the control fails, refer to DANGEROUS CONDITIONS AND RISKS section.

EXTRAORDINARY

- We recommend the replacement of the electrical heating element (into the specific towel radiator) every 5 years.

CLEANING

- To clean the electric heating element, use only a dry and clean soft cloth.
- Make small locally round movements.

TO UNINSTALL

IN 'ELECTRIC ONLY' HEATING ELEMENT INSTALLATION

- Disconnect the cable from the mains power.
- Remove the electrical towel radiator from the wall and reverse carefully leaning it on a soft cloth/surface.
- Using a 27mm spanner unscrew the heating element, rotating it anticlockwise until the heating element thread is completely off from the towel radiator ½" GAS female thread.
- Remove the heating element from the towel radiator.

WARNING! AFTER DISCONNECTING, THE ELECTRICAL HEATING ELEMENT CAN NOT BE REUSED. REPLACE IT WITH A NEW ONE.

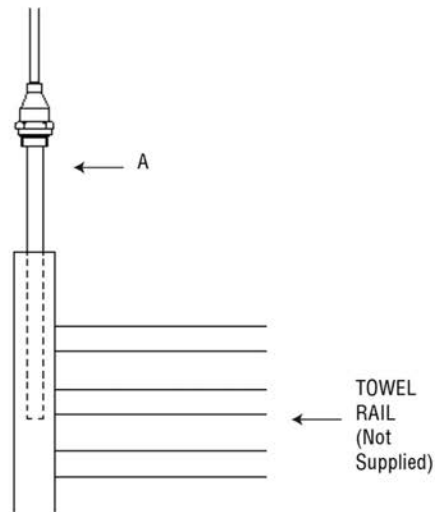

IN 'DUAL FUEL' INSTALLATION CENTRAL HEATING AND HEATING ELEMENT

- Disconnect the cable from the mains power.
- Close both radiator valves, remove the water from the towel radiator and dry the working area.
- Remove the towel radiator from the wall and reverse it carefully leaning it on a soft cloth/surface.
- Using a 27mm spanner unscrew the T-piece with screwed the electrical heating element, rotating it anticlockwise until T-piece thread is completely off from towel rail ½" GAS female thread.
- Remove T-piece with screwed the electrical heating element from the towel rail.

WARNING! AFTER DISCONNECTING, THE ELECTRICAL HEATING ELEMENT CAN NOT BE REUSED. REPLACE IT WITH A NEW ONE.

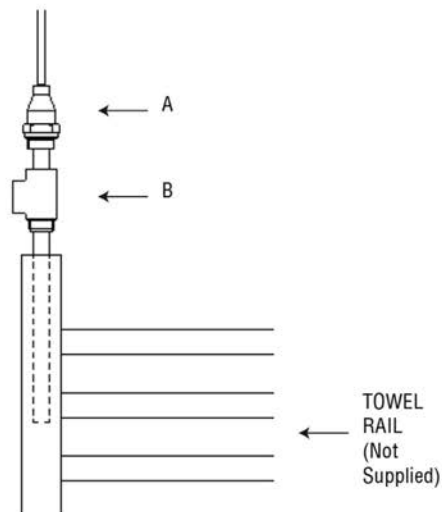

DIAGNOSTIC

If the towel radiator does not heat at all, this may indicate operation failure and the product must be replaced. If the Magnetothermic Circuit Breaker has operated disconnect the electrical heating element and refer to dangerous conditions and risk section.

SPARE PARTS

The electrical heating element must be replaced totally.

IMPORTANT: In case of any doubt or insufficient information, please, do not install or use the electrical heating element and contact the Customer Care Line.

IMPORTANT: Please, retain these instructions for future reference.